

Data Sheet



Article number: 0108047

Description: Retaining ring JK 30 DIN 984

Measures

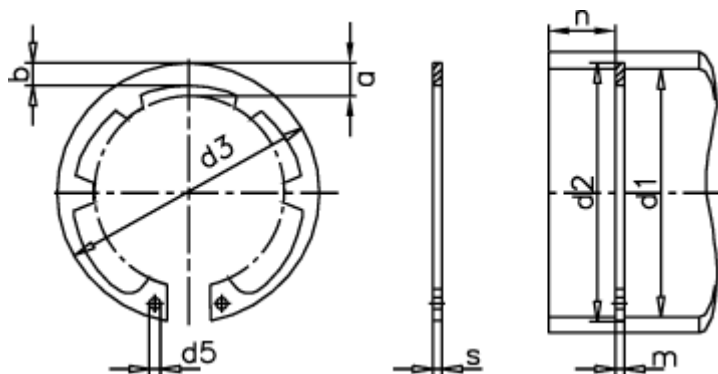

a max	= 4.9	FN kN	= 11.3	s	= 1.20
AN mm ²	= 67.5	FRg kN	= 4.6	t	= 0.70
b	= 3.2	FR kN	= 13.7	tol	= +0,25
d1	= 30	g	= 1.0	tol	= -0.06
d2	= 31.4	K kN-mm	= 26.6	tol	= +0,50-0,25
d3	= 32.1	m min	= 1.30	Tong	= ZGJ-2
d5 min	= 2.0	Nominal drive	= 2.1	Weight kg/1000	= 2.35
Description	= JK 30	Number of serrations	= 6		